

Urban lighting

LEAF

LT-OS



LUMINAIRE

- Die-cast aluminium body (EN 47100).
- Double layer polyester powder paint resistant to corrosion and salt spray fog.
- Silicone rubber gaskets.
- AISI 316 stainless steel external screws.
- Driver protected against voltage surges up to 10kV.
- PMMA lenses for LEDs.
- Screen made of 5mm thermal-shock resistant tempered glass.
- High quality LED sources characterized according to IES TM-30, with high color consistency <3SDCM and long useful life >60000 hours at L80.
- It complies with standards EN 60598-1 and EN 60598-2-3.

INSTALLATION

- Post-top installation (Ø60mm reduction).
- Mounting including universal pole flange for lateral and pole-top attachment, pole flange adjustable from 15° to -5° in 2.5° increments
- Recommended pole height 4,000 - 12,000 mm
- Options controls: DALI, Photocell, Motion sensor.
- LT-OS pole-top luminaires are designed for simple and straightforward maintenance – with housings that open without the use of any tools. The pole flange is suitable for universal use as a top or lateral-mounted luminaire.



Technical information

Light source:	LED, 4000/5000K, CRI>70
Luminaire efficacy:	130lm/W
Luminaire:	50/100/150/200W, 6500/13000/19500/26000LM
LED life time:	> 60000h - L80 - B20 (Ta 25°C)
High colour consistency:	< 3 SDCM
Power supply:	220-240V 50/60Hz(120-277V)
Wiring:	ON/OFF
Optics:	TYPE II / III / IV / Type V Square Medium / Type V Wide (Round)
Color:	Aluminium - 21
Fixture Finish:	Gray

Example: LT-OS-50W-3K7-3-NV

LT-OS										
Model	Nominal Watts	CCT		Distribution		Voltage		Options		
LT-OS LEAF	50W	6500LM		3K7	3000K, 70 CRI	2	Type II	UNV	120-277V	<ul style="list-style-type: none"> • Twist-lock photocell. • Motion sensor. • 5-pin wireless photoelectric control for added dimming feature. • 7-pin wireless photoelectric control for for dimming and additional I/O connections for customer use
	100W	13000M		4K7	4000K, 70 CRI	3	Type III	NV	220-240V	
	150W	19500LM		5K7	5000K, 70 CRI	4	Type IV	347	347V	
	200W	26000LM				4W	Type IV Wide	480	480V	
						5QM	Type V Square Medium	DALI	220-240V	
						5W	Type V Wide (Round)	Consult factory		

LEAF

LT-OS

ISOFOOT CANDLE PLOT (TYPE II)

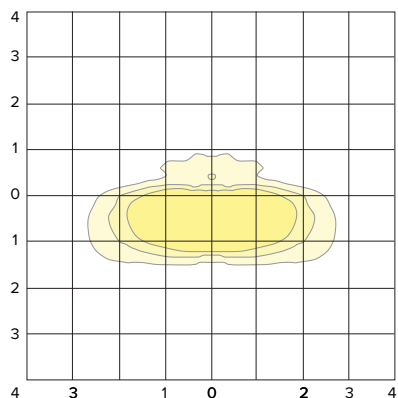

ISOFOOT CANDLE PLOT (TYPE III)

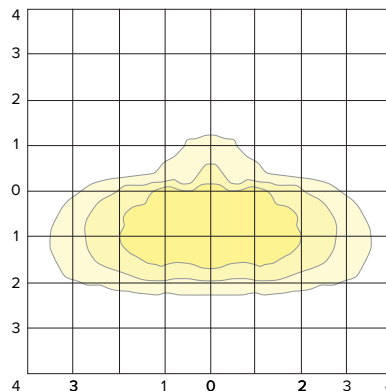

ISOFOOT CANDLE PLOT (TYPE IV)

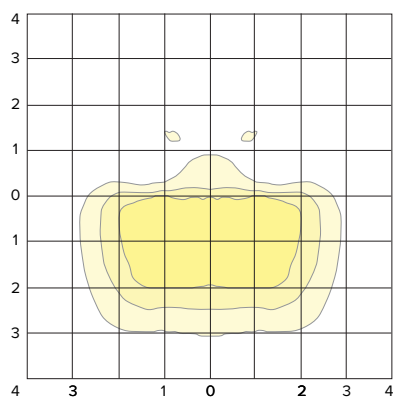

ISOFOOT CANDLE PLOT

Type V Square Medium

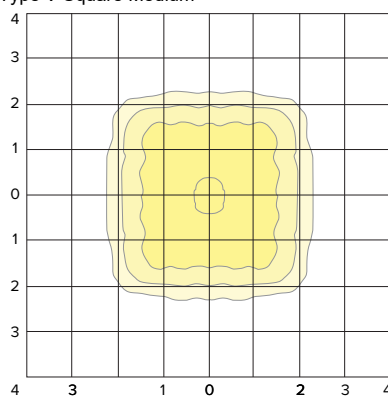

ISOFOOT CANDLE PLOT

(Type V Wide (Round))

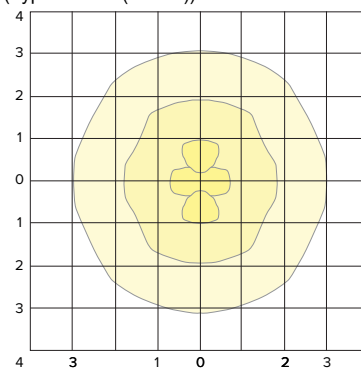

50/70W

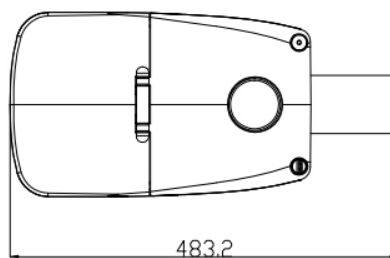
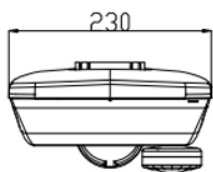

Package Size: L:42*B:27*H:16cm
G W: 3.8kg

100W

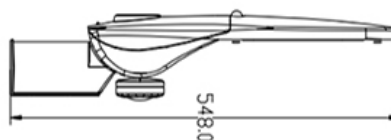
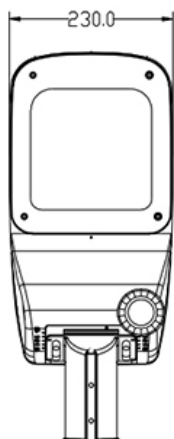

Package Size: L:48.5*B:27.5*H:16cm
G W: 4.2kg

150W

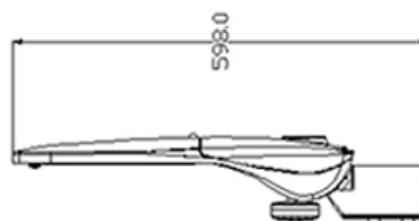

Package Size: L:54.5*B:30.5*H:16cm
G W: 5.5kg

200W

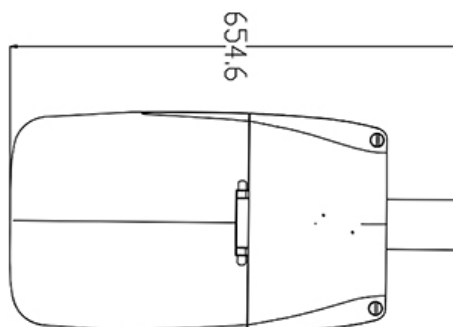
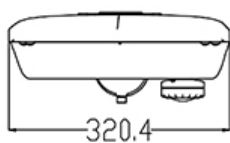

Package Size: L:61.5*B:37.5*H:18.5cm