

Rugged cast-aluminum, corrosion-resistant housing with polyester powder paint for lasting durability. LED lamp heads are thermally isolated from the driver that is located in the rear housing, promoting a long service life. Lenses are sealed to keep out moisture, dirt and bugs. LEDs maintain 70% of light output at 50,000 hours of service life.



Driver Info

Type:	Constant Current
Voltage:	120
Input Watts:	20W
Efficiency:	95%

LED Info

Watts:	20W
Color Temp:	2700-6500K
Color Accuracy:	>70
L70 Lifespan:	100000
Lumens:	2123
Efficacy:	101.5 lm/W



Weight: 2.58 lbs (1.17 KG)

Technical Specifications

Listings

ETL, cETL Listing:

Suitable for wet locations. Suitable for mounting within 1.2m (4ft) of the ground.

LM-80 Testing:

LED luminaires and LED components have been tested by an independent laboratory in accordance with IESNA LM-79 and LM-80.

Electrical

Driver:

Constant Current, Non Isolated, 120V, 50/60 Hz, 4KV surge protection

THD:

9.9% at 120V

Power Factor:

90.3% at 120V

LED Characteristics

LED:

High performance OSRAM LEDs

Lifespan:

50,000-hour LED lifespan based on IES LM-80 results and TM-21 calculations

Color Consistency:

7-step MacAdam Ellipse binning to achieve consistent fixture-to-fixture color

Color Stability:

LED color temperature is warranted to shift no more than 200K in CCT over a 5 year period

Color Uniformity:

Li-tian's range of CCT (Correlated Color Temperature) follows the guidelines for the American National Standard for Specifications for the Chromaticity of Solid State Lighting (SSL) Products.

Construction

Cold Weather Starting:

Minimum starting temperature is -40°C (-40°F)

Maximum Ambient Temperature:

Suitable for use in 40°C (104°F)

Housing:

Precision die-cast aluminum housing

Lens:

Polycarbonate molded lens

Reflector:

Specular thermoplastic reflector

Gaskets:

High-temperature silicone

Finish:

Formulated for high-durability and long lasting color

Green Technology:

Mercury and UV-free. RoHS compliant components.

MOUNTING

2 Options:

Wall Mount and U Bracket Mount. Wall Mount directly over a standard junction box or direct-to-wall.

Options

Lighting Control

Motion Sensor standard, swivel photocell and floodlight optional

Finish Color

White finish standard, black or bronze optional

Dimensions

unit:mm

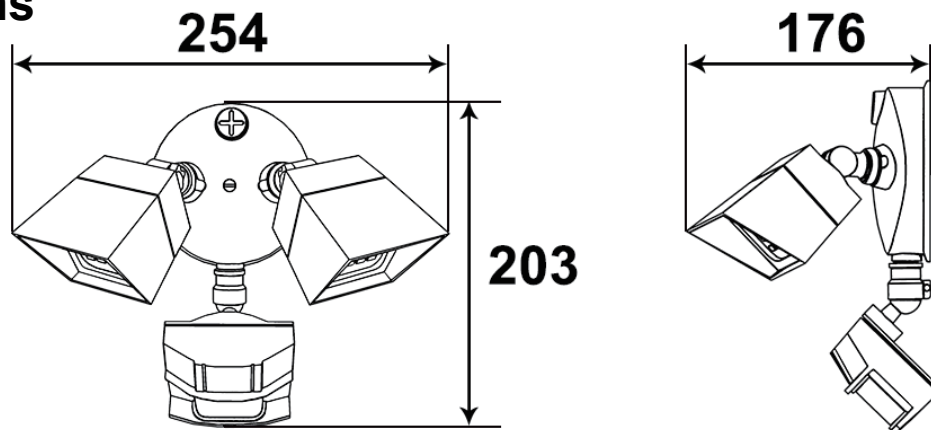

Options

Motion Sensor

Technical Parameters

Input Voltage: AC110-130V

Power Frequency: 50/60Hz

Detection Range: 180°

Detection Distance: MAX 60ft (adjustable)

Time Setting: After detecting motion, stay on for 5sec, 1min, 5min, or 10min

Detection Motion Speed:0.6-1.5m/s

Installation Height: 0~15 ft

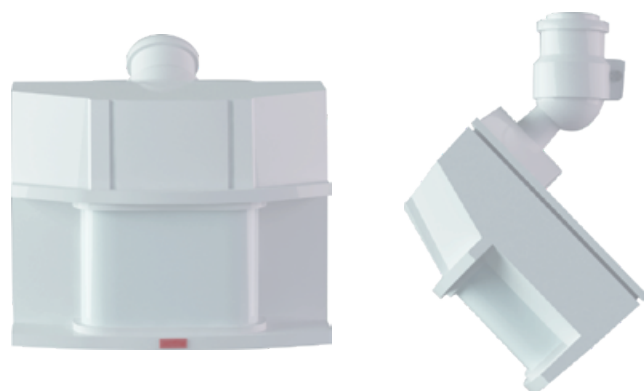

Feature

Photocell

The light automatically turns on/off according to outside light levels (dusk to dawn)

Distance Setting

Adjusts the detection distance Max: 60ft when installed at 8ft

TIME

After detecting motion, light stays on for 5, 10, 30, or 60 seconds.

Learn More

Tel: +86-760-23757187

Fax: +86-760-23757185

Website: www.ilitianled.com

ADD: Block B 4/F, No.2 Yihui 2nd Road Maohui Industry, Sisha, Henglan Town, Zhongshan City, Guangdong Province, China.