

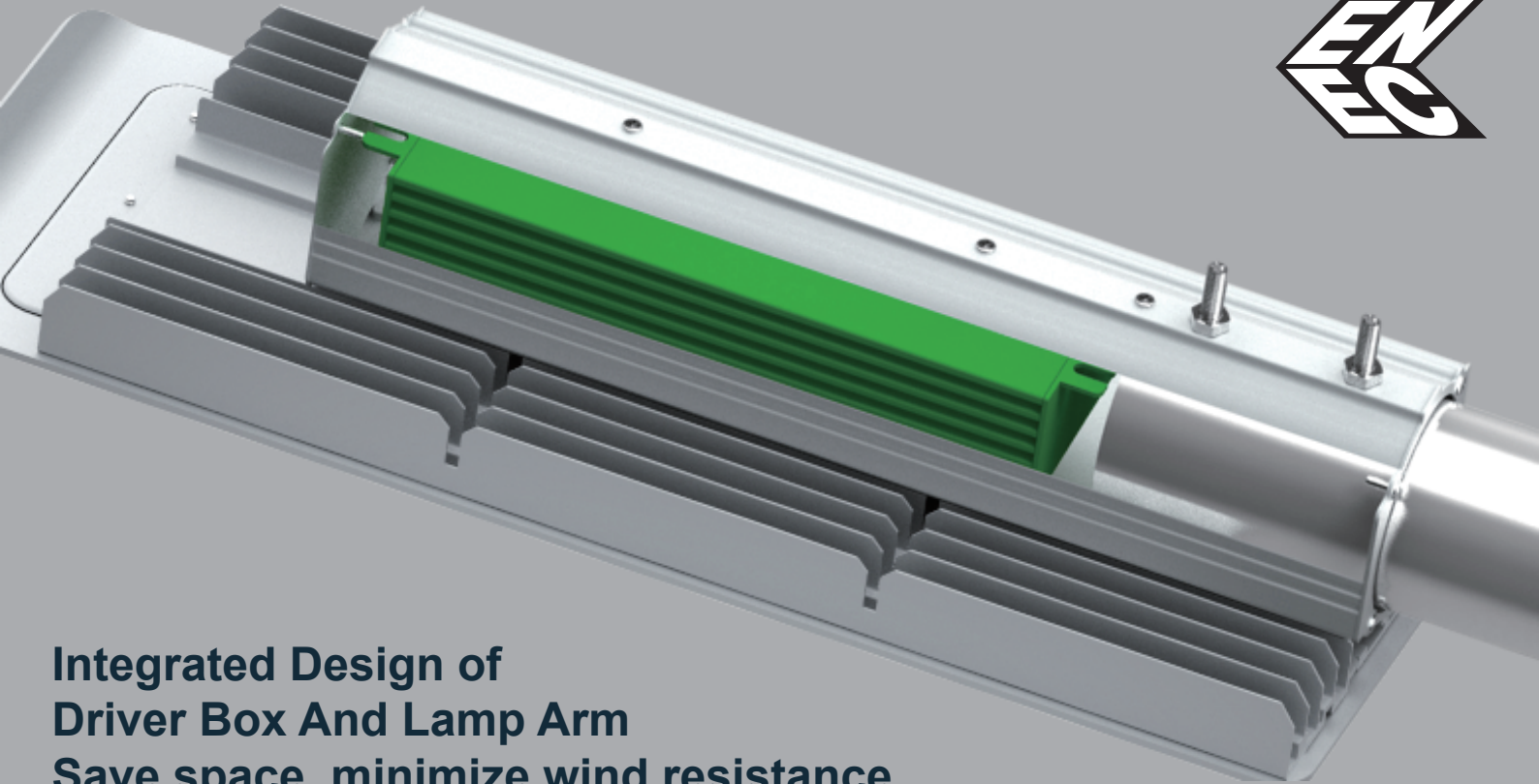

LI-TIAN LIGHTING

# LED Economical Road Light

LT-T-014 Series



**Integrated Design of  
Driver Box And Lamp Arm  
Save space, minimize wind resistance**

LED Road Light power box and light arm integrated design saving space and minimizing wind resistance. The lower glare of the will be sure to offer improved visual comfort, widely used in trunk roads, highways, elevated roads, urban streets, overpasses, sidewalks, etc.



**30W**



**40W**



**60W**



**90W**

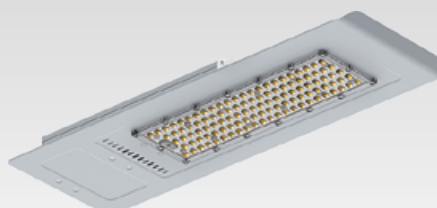

**120W**

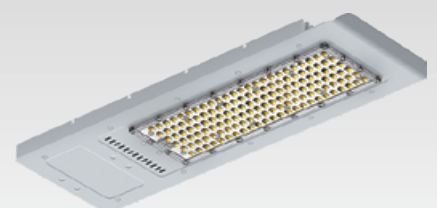

**150W**

# Configurable Street Light Adapter

The street light adapter, with a clear scale, 120 ° angle adjustable.

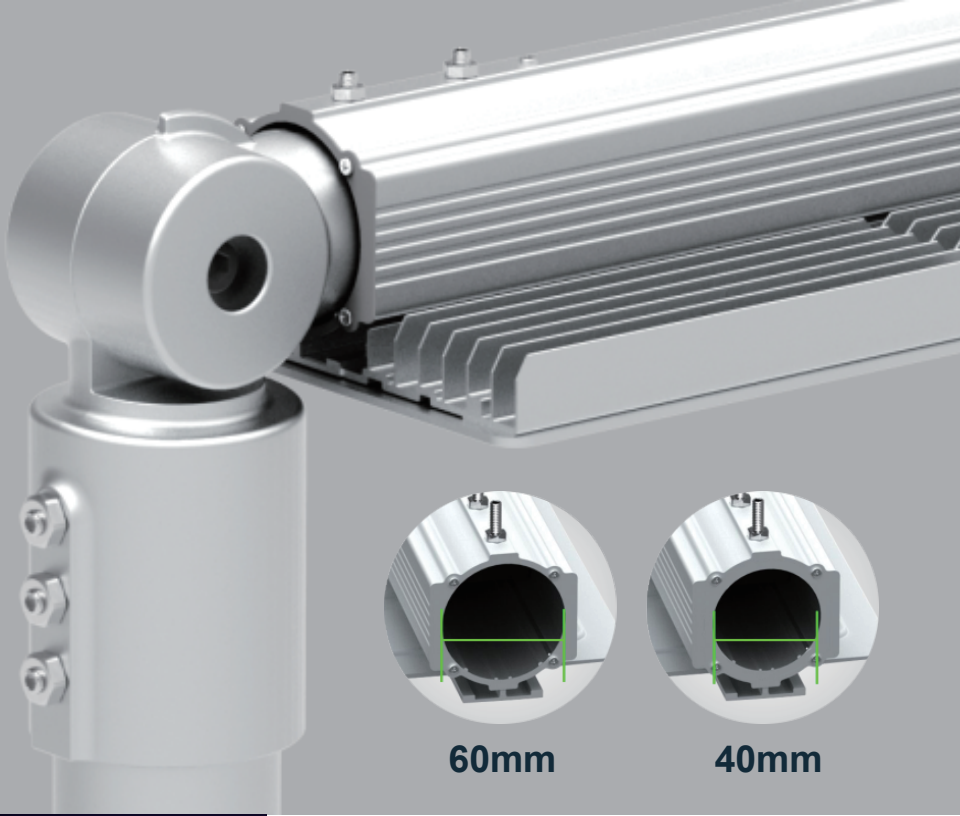

- ENEC listed
- 120-277VAC
- 3000K,4000K, 5000K CCT standard
- High performance CREE LEDs
- The integrated design of driver box and arm can save the space.
- Al1060 Aluminum Material, 200W/M.K thermal coefficient, lighter in weight.
- 5 years warranty

## SIZE

Unit:mm

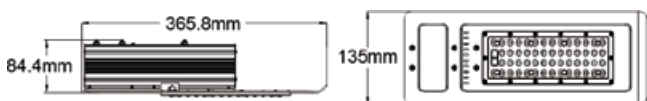

**30W**

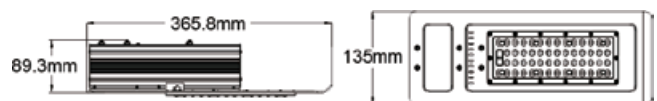

**40W**

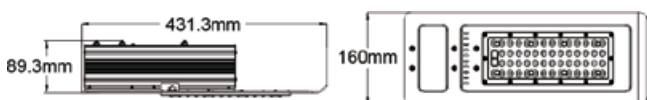

**60W**

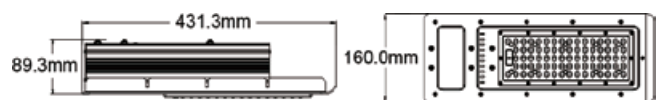

**90W**



**120W**



**150W**

See how Litian LED luminaires can provide a complete solution for your area lighting needs. Visit [www.ilitianled.com](http://www.ilitianled.com) more information.