

Vandal resistant polycarbonate molded housing cover and lens, maximize performance and life of LED Driver is mounted in direct contact with the chamber for a low operating temperature and long life Polyester powder-coated finish, rust and corrosion proof, stabilized to extreme climate changes without cracking or peeling.



## Driver Info

Type:	Constant Current
Voltage:	120V
Input Watts:	25W
Efficiency:	87%

## LED Info

Watts:	25W
Color Temp:	2700-6500K
Color Accuracy:	>70
L70 Lifespan:	100000
Lumens:	2225
Efficacy:	89 LPW



Weight: 1.74 lbs (0.79 KG)

## Technical Specifications

### Listings

#### ETL, cETL Listing:

Suitable for wet locations. Suitable for mounting within 1.2m (4ft) of the ground.

#### LM-80 Testing:

LED luminaires and LED components have been tested by an independent laboratory in accordance with IESNA LM-79 and LM-80.

### Electrical

#### Driver:

Constant Current, Non Isolated, 120V, 50/60 Hz, 4KV surge protection

#### THD:

9.9% at 120V

#### Power Factor:

90.3% at 120V

### LED Characteristics

#### LED:

High performance CREE LEDs

#### Lifespan:

50,000-hour LED lifespan based on IES LM-80 results and TM-21 calculations

#### Color Consistency:

7-step MacAdam Ellipse binning to achieve consistent fixture-to-fixture color

#### Color Stability:

LED color temperature is warranted to shift no more than 200K in CCT over a 5 year period

### Color Uniformity:

Li-tian's range of CCT (Correlated Color Temperature) follows the guidelines for the American National Standard for Specifications for the Chromaticity of Solid State Lighting (SSL) Products.

### Construction

#### Cold Weather Starting:

Minimum starting temperature is -40°C (-40°F)

#### Maximum Ambient Temperature:

Suitable for use in 40°C (104°F)

#### Housing:

polycarbonate molded housing cover

#### Back Housing:

Precision die-cast aluminum back housing

#### Lens:

polycarbonate molded lens

#### Gaskets:

High-temperature silicone

#### Finish:

Formulated for high-durability and long lasting color

#### Green Technology:

Mercury and UV-free. RoHS compliant components.

### MOUNTING

#### Wall Mount:

Wall Mount directly over a standard junction box or direct-to-wall.

### Options

#### Lighting Control

Photocell sensor standard, Floodlight optional

#### Finish Color

Black finish standard, bronze optional

## Dimensions

unit:mm

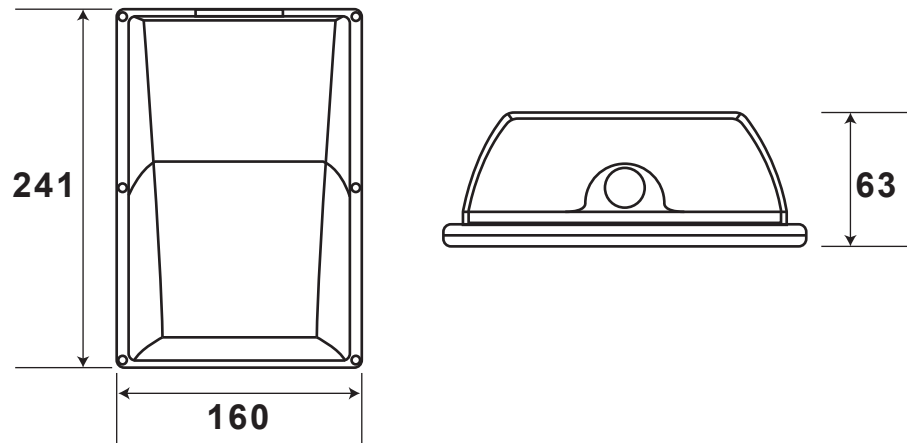

## Learn More

Tel: +86-760-23757187  
Fax: +86-760-23757185  
Website: [www.litianled.com](http://www.litianled.com)  
ADD: Block B 4/F, No.2 Yihui 2nd Road Maohui Industry, Sisha, Henglan Town,  
Zhongshan City, Guangdong Province, China.