

LED Parking Garage and Canopy Luminaire



Long Life and Low Maintenance Cost

In addition to delivering superior performance, the LED Parking Garage and Canopy Luminaire is designed for low maintenance, long life and low cost of ownership. These are key benefits which provide compelling justification to retrofit traditional HID solutions, or allow end users to capitalize on these advantages in new construction applications. The luminaire can be tailored to meet your most important needs without compromising on specification features. The fixture housing is IP66 rated, which provides years of reliable operation with minimal service requirements.

Universal functionality, energy-efficient optical control, easy installation and a low-profile design prove that the LED Parking Garage and Canopy Luminaire is the best choice for parking garage, stairwell, low-bay and canopy illumination.

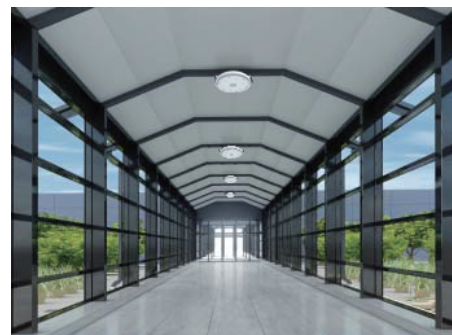

Design Performance Features

Construction

- Low profile, die-cast aluminum housing
- Universal, galvanized steel quick-mount plate
- Mounts to standard one-gang, two-gang and 4" round wet location junction boxes
- IP65 rated
- 3G vibration rated
- ETL and cETL wet location listed / DLC

Finish

- Five-stage super durable TGIC paint resists extreme weather conditions while providing optimal color and gloss retention. Available in white, bronze, black metallic finishes.



white



bronze



black

Electrical

- Operates in -40°C to 40°C ambient conditions.
- 120-277V 50/60Hz
- Standard proprietary circuit module designed to withstand 6kV of transient line surge
- Optional occupancy sensor provides additional energy savings
- Scalable in three lumen packages ranging from 5600 to 9750 nominal delivered lumens

Optical

- Available wide (WQ) distributions
- Standard in 5000K CCT, optional 3000K and 4000K CCT
- Minimum 70 CRI

Warranty

- Five-year warranty

Design Practices

Lighting design for parking structures normally follows specific published guidelines and design practices as defined by the Illuminating Engineering Society of North America (IESNA). IESNA publishes recommended guidelines to help facilitate garage lighting design. The following minimum guidelines are established for safety and security of pedestrians and property within the space.

IESNA RP-20-14 Recommended Maintained Illuminance Values for Parking Garage Facilities

Area of Illumination	Minimum Footcandle Level (On Floor)	Maximum / Minimum Footcandle Level (On Floor)	Vertical Reading Area Of Illumination (On Floor)	Minimum Footcandle Level (60" Above Floor) ¹
Basic	1.0	10:1	Basic	0.5
Ramps (Day)	2.0	10:1	Ramps (Day)	1.0
Ramps (Night)	1.0	10:1	Ramps (Night)	0.5
Entrance Areas (Day)	50	10:1	Entrance Areas (Day)	25
Entrance Areas (Night)	1.0	10:1	Entrance Areas (Night)	0.5
Stairways	2.0	N/A	Stairways	1.0

NOTE: 1 Vertical reading is taken at lowest point of horizontal illumination level.

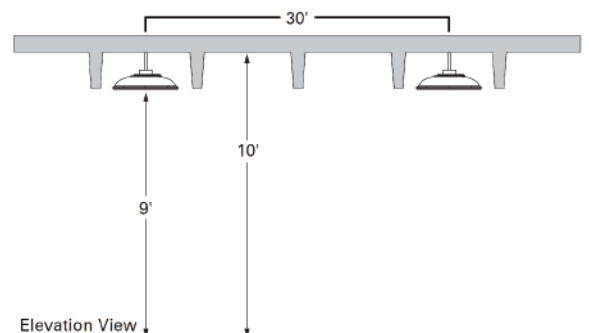

Center of Drive Fixture Location

Fixture spacing = 30' centered down drive lane; 60' on center between driving lanes (one per bay). Fixtures mounted 9' to bottom of fixture, even with the bottom of t-joists.

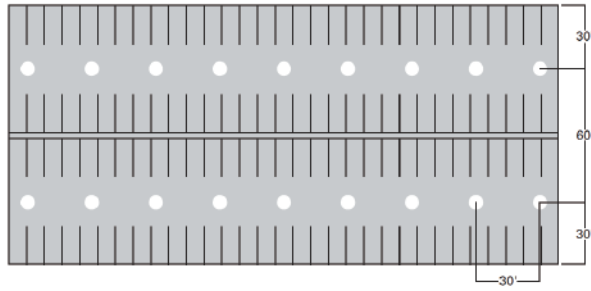

Sides of Drive Fixture Location

Fixture spacing = 30' x 30' on center spacing (two per bay). Fixtures mounted 9' to bottom of fixture, even with the bottom of t-joists.

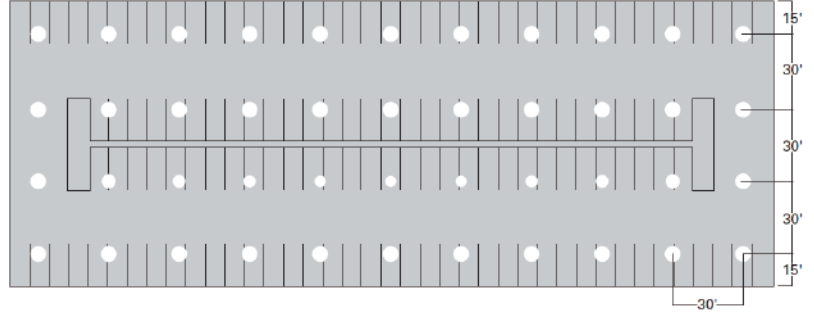

Type V Wide

Wide symmetric distribution for general parking garage applications that require even illumination for safety.

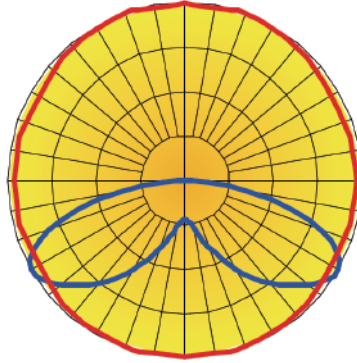

Mounting Options



Surface Mount (Standard)



Junction Box Plate Mount



Trunnion Mount



Pendant Mount



Cable Mount

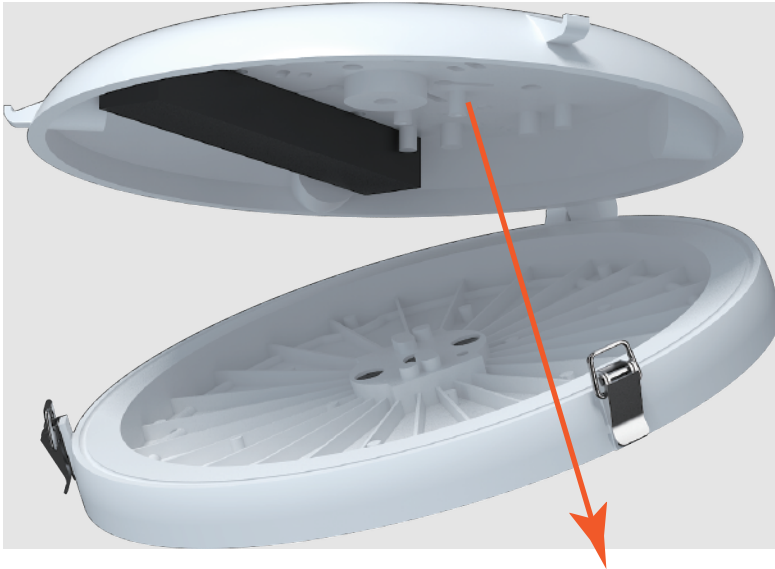

1. Once you open the back box from the garage light, you will notice there are filled in slots which can be used as a guide to drill holes (depending on the Junction Box being used, drill holes on the necessary slots).

2. The luminaire also comes with a foam felt pad to prevent any liquids from entering the fixture. Place the felt pad in between the fixture and the mounting surface.

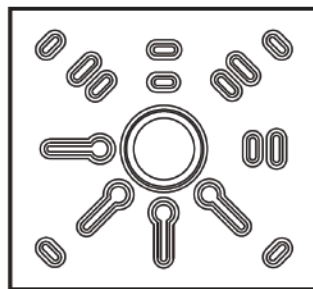

3. Mount the Back Box to the ceiling using mounting screws (not included). The number and size of the mounting screws must be calculated by a certified personnel and may vary depending on the mounting surface and junction box being used.

Wireless Lighting Controls

Dimming Occupancy Sensor

Optional integral occupancy sensing reduces power consumption and enhances payback. Factory programmed to 50% in low mode and field adjustable with the remote programmer.



Typical Applications

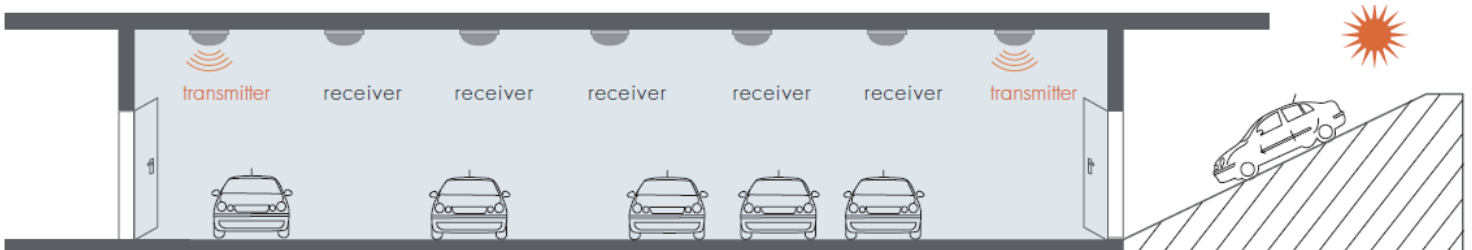

With sufficient natural light, the sensor is not triggered by motion.

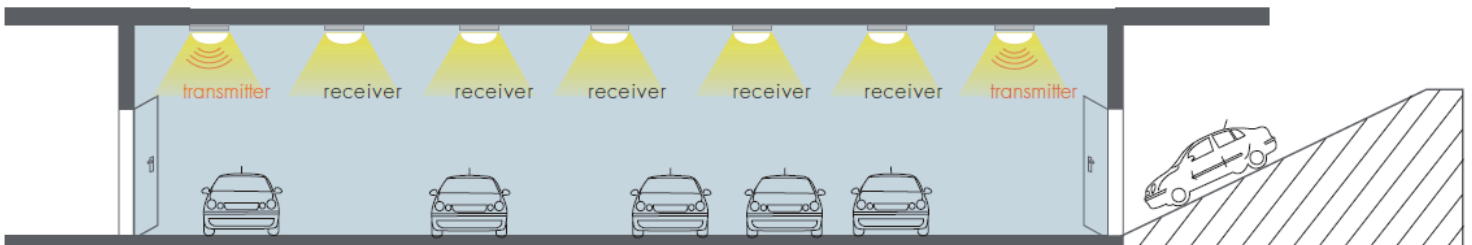

With insufficient natural light, the sensor is triggered by motion, the transmitter switches on the light and send RF ON signal to all salves.

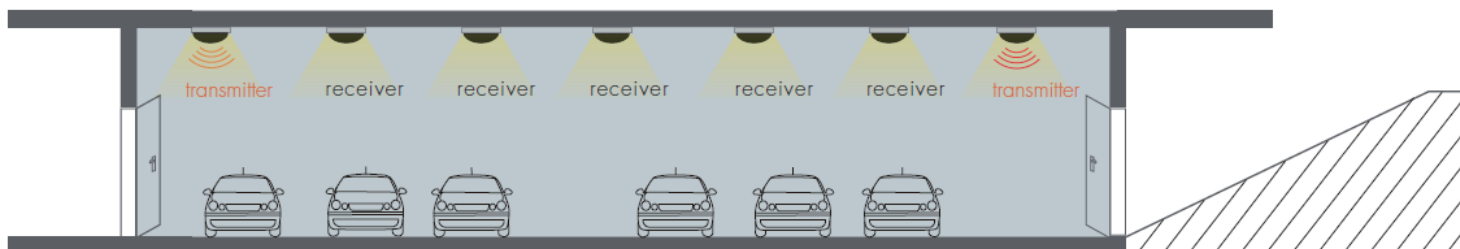

After the hold-time, the whole group of lamps dim to pre-defined dimming level when no movement is detected.

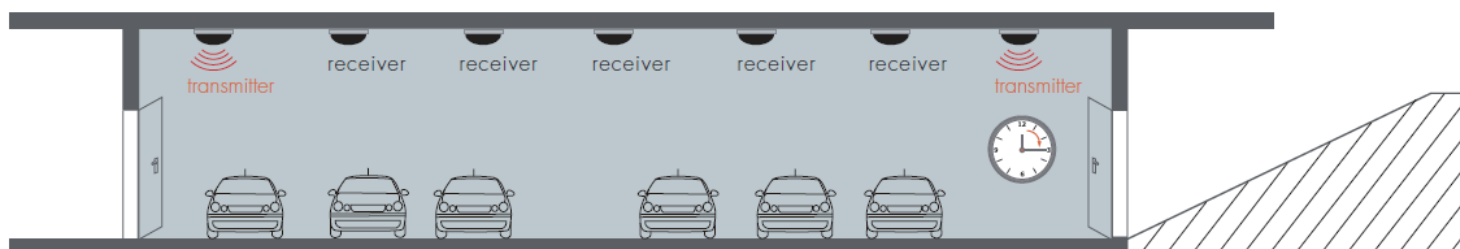

The whole group of lamps switch off automatically after the stand-by period.

Detection Pattern

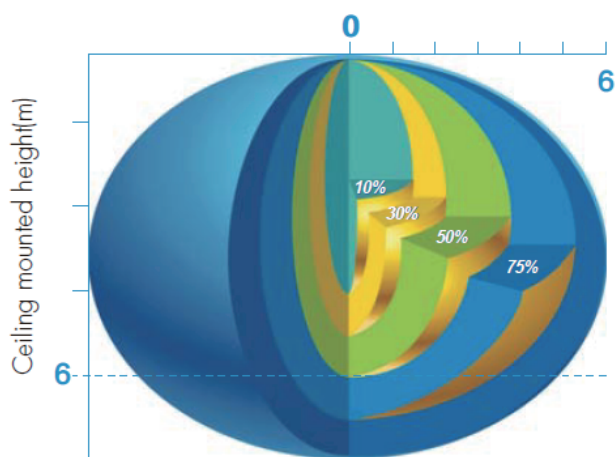

Ceiling mounted detection pattern (m)

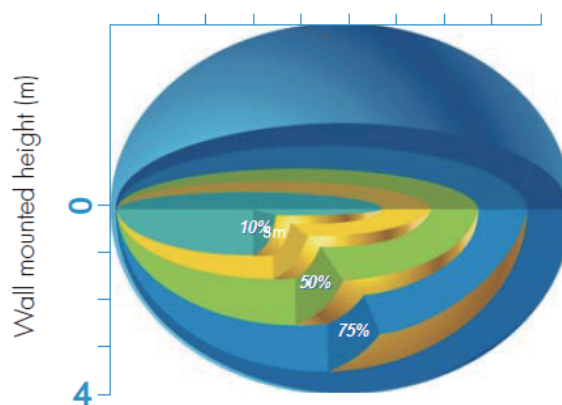

Wall mounted detection pattern (m)

Dimensions

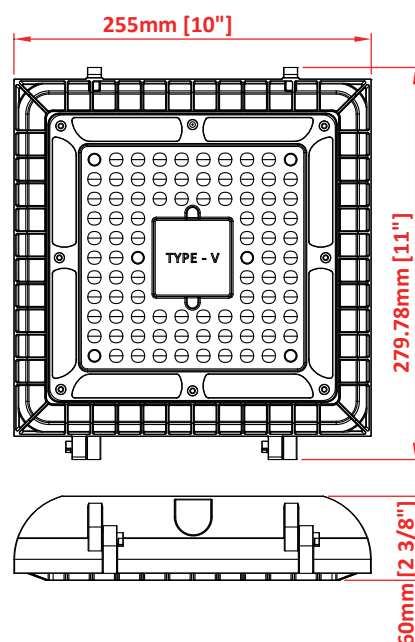
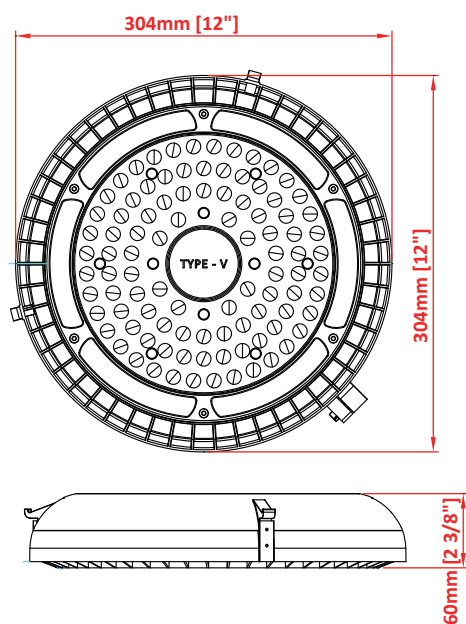

Ordering information

Example: LT-YC-60W-50K-UNV-SM

						Options			
model	Lumens	power	Color Temperature	Distribution	Voltage	Motion sensing	Mounting	Dimming controls	Finish
LT-YC	140LM/W	40W	WW-30K	Type V Wide	UNV Universal 120- 277V	MSP=Integrated Sensor for ON/OFF Operation, 13' - 19' Mounting Height	SM=Surface Mount (Standard)	1-10V Dimming Resistor Dimming	Black White Bronze
LT-FC	130LM/W	LT-YC:CREE 3030-96pcs LT-FC:CREE 3030-84pcs	Warm White 3000K (70 CRI)						
	130LM/W	60W LT-YC:CREE 3030-96pcs LT-FC:CREE 3030-84pcs	NW-40K Neutral White 4000K (70 CRI)						
		75W LT-YC:CREE 3030-96pcs	CW-50K Cool White 5000K (70 CRI)				JBPM=Junction Box Plate Mount TM=Trunnion Mount PM=Pendant Mount CM=Cable Mount	Pwm Three-in-one Dimming (Standard)	

Take the next step

See how Litian LED luminaires can provide a complete solution for your area lighting needs. Visit www.litianled.com more information.